



S E R V E R

SERVE BETTER™

Squeeze Bottle Holders

**2.88" DIAMETER, 16 OZ
SQUEEZE BOTTLES**

(not intended for
heated applications)

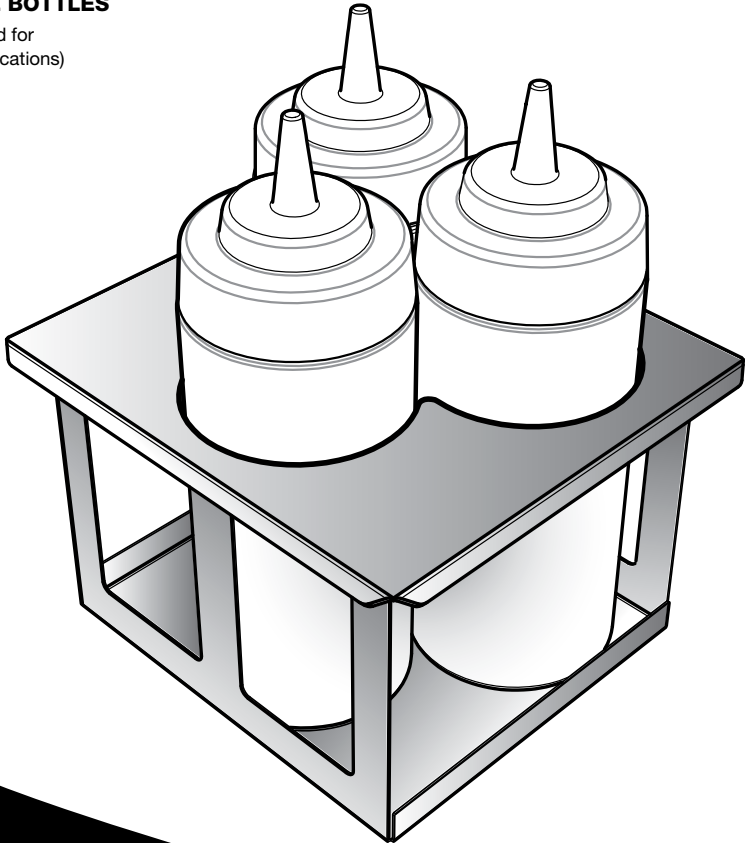

Thank You

...for purchasing our squeeze bottle holder.
Its contoured lid and open-frame design keep
cold air circulating, yet contained—holding bottles of
dressings and sauces up to 10° F colder than in pans.

SERVE BETTER WITH COLDER SQUEEZE BOTTLES

SQUEEZE BOTTLE HOLDERS

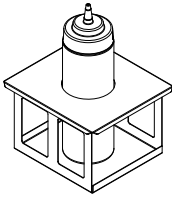

MODEL
SBH-1
86828

SINGLE

Fills the space of 1/6 size pan.
Includes 1 squeeze bottle.

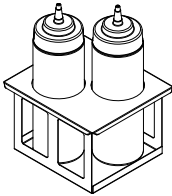

MODEL
SBH-2
86829

DOUBLE

Fills the space of 1/6 size pan.
Includes 2 squeeze bottles.

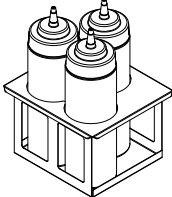

MODEL
SBH-3
86831

TRIPLE

Fills the space of 1/6 size pan.
Includes 3 squeeze bottles.

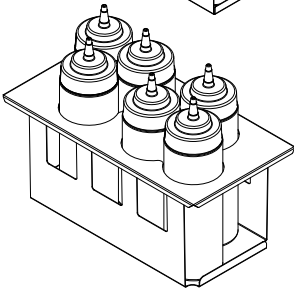

MODEL
SBH-6
87045

SEXTUPLE

Fills the space of 1/3 size pan.
Includes 6 squeeze bottles.
(Holder without bottles: **87042**)

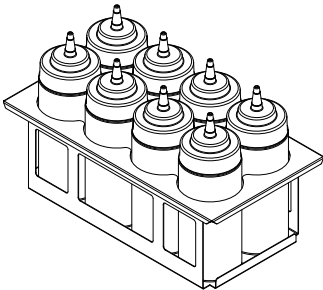

MODEL
SBH-8
86974

OCTUPLE

Fills the space of 1/3 size pan.
Includes 8 squeeze bottles.

FOR FAST SWITCH-OUT...

Be sure to have extra squeeze bottles on hand.

Order part number 86818
16 oz TableCraft™ Bottle

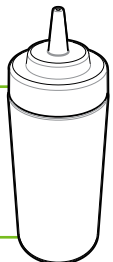

SAFETY



According to food and safety regulations, most foods must be stored and/or served at certain temperatures or they could become hazardous. Check with local food and safety regulators for specific guidelines. Server Products, Inc. cannot be responsible for the serving of potentially hazardous product.

Be aware of the product you are serving and the temperature the product is required to maintain. Server Products, Inc. can not be responsible for the serving of potentially hazardous product.

The squeeze bottles included are not intended for heated applications.

IMPORTANT

Clean, rinse, sanitize, and dry parts daily or regularly to comply with local sanitization requirements.



NSF International listed.

CLEANING

1 WASH

all parts with dishwashing detergent and hot water.

2 RINSE

all parts thoroughly with clear water.

3 SANITIZE

all parts according to local sanitization requirements. All parts in contact with food must be sanitized.

5 AIR DRY

all parts fully.



YES!

Use dishwashing soap and hot water

- Squeeze bottles are low-temperature dishwasher safe
- Do not use abrasive, caustic or ammonia based cleansers.
- Do not use cleansing agents with high concentrations of acid, alkaline or chlorine.
- Do not use metal scrapers or cleaning pads that could scratch surfaces.

CARE OF STAINLESS STEEL

This holder is constructed of stainless steel— one of the best materials for food serving and storage.

If you notice corrosion beginning on any stainless steel surface, you may need to change the cleansing agent, sanitizing agent, or the cleaning procedures you are using.

- A mildly abrasive nylon or brass brush may be used to remove any stubborn food or mineral deposits on interior surfaces of unit.
- Fully rinsing and drying all parts can help prevent corrosion. Elements and minerals in tap water can accumulate on stainless steel parts and create corrosion.
- Do not use abrasive, caustic or ammonia based cleansers.
- Do not use products containing acids, alkalines, chlorine, or salt. These agents can corrode stainless steel.
- Do not use metal scrapers or cleaning pads that could scratch surfaces.

SERVER PRODUCTS LIMITED WARRANTY

2 YEAR
WARRANTY



Server Products equipment is backed by a two-year limited warranty against defects in materials and workmanship.

For complete warranty information go to:

www.Server-Products.com

GENERAL SERVICE, REPAIR OR RETURNS

Before sending any item to Server Products for service, repair, or return, contact Server Products customer service to request a **Return Authorization Number**. Merchandise must be sent to Server Products with this number. Service is extremely prompt. Typically, units are repaired and ship out within 48 hours of receipt.

Merchandise being returned for credit must be in new and unused condition and not more than 90 days old and will be subject to a 20% restocking charge.

HELP or ORDERING REPLACEMENT PARTS

Server Products Inc.

3601 Pleasant Hill Road
Richfield, WI 53076 USA



262.628.5600 | 800.558.8722



SPSALES@SERVER-PRODUCTS.COM

Please be prepared with your **Model, Part and Series Number**. This information is located on the top of the holder. See page 2 for individual part numbers.